

# SKT 1200/18 E



**Capsule Thyristor**

## Line Thyristor SKT 1200/18 E

### Features

- Hermetic metal case with ceramic insulator
- Capsule package for double sided cooling
- Shallow design with single sided cooling
- International standard case
- Off-state and reverse voltages up to 1800 V
- Amplifying gate

### Typical Applications\*

- DC motor control (e. g. for machine tools)
- Controlled rectifiers (e. g. for battery charging)
- AC controllers (e. g. for temperature control)
- Recommended snubber network e. g. for  $V_{VRMS} \leq 400$  V:  $R = 33 \Omega / 32$  W,  $C = 1 \mu F$

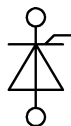

**SKT**

Absolute Maximum Ratings				
Symbol	Conditions		Values	Unit
<b>Chip</b>				
$I_{T(AV)}$	sinus 180°	$T_c = 85 \text{ °C}$	1200	A
		$T_c = 100 \text{ °C}$	840	A
$I_{TSM}$	10 ms	$T_j = 25 \text{ °C}$	30000	A
		$T_j = 125 \text{ °C}$	25500	A
$i^2t$	10 ms	$T_j = 25 \text{ °C}$	4500000	A <sup>2</sup> s
		$T_j = 125 \text{ °C}$	3251250	A <sup>2</sup> s
$V_{RSM}$			1800	V
$V_{RRM}$			1800	V
$V_{DRM}$			1800	V
$(di/dt)_{cr}$	$T_j = 125 \text{ °C}$		125	A/ $\mu$ s
$(dv/dt)_{cr}$	$T_j = 125 \text{ °C}$		1000	V/ $\mu$ s
$T_j$			-40 ... +125	°C
<b>Module</b>				
$T_{stg}$			-40 ... +130	°C

Characteristics					
Symbol	Conditions	min.	typ.	max.	Unit
<b>Chip</b>					
$V_T$	$T_j = 25 \text{ °C}$ , $I_T = 3600$ A			1.65	V
$V_{T(TO)}$	$T_j = 125 \text{ °C}$			0.95	V
$r_T$	$T_j = 125 \text{ °C}$			0.18	m $\Omega$
$I_{DD}; I_{RD}$	$T_j = 125 \text{ °C}$ , $V_{DD} = V_{DRM}$ ; $V_{RD} = V_{RRM}$			160	mA
$t_{gd}$	$T_j = 25 \text{ °C}$ , $I_G = 1$ A, $di_G/dt = 1$ A/ $\mu$ s		1		$\mu$ s
$t_{gr}$	$V_D = 0.67 \cdot V_{DRM}$		2		$\mu$ s
$t_q$	$T_j = 125 \text{ °C}$	100		250	$\mu$ s
$I_H$	$T_j = 25 \text{ °C}$		250	500	mA
$I_L$	$T_j = 25 \text{ °C}$ , $R_G = 33 \Omega$		500	2000	mA
$V_{GT}$	$T_j = 25 \text{ °C}$ , d.c.	3			V
$I_{GT}$	$T_j = 25 \text{ °C}$ , d.c.	250			mA
$V_{GD}$	$T_j = 125 \text{ °C}$ , d.c.			0.25	V
$I_{GD}$	$T_j = 125 \text{ °C}$ , d.c.			10	mA
$R_{th(j-c)}$	continuous DC	SSC			K/W
		DSC		0.021	K/W
$R_{th(j-c)}$	sin. 180°	SSC		0.054	K/W
		DSC		0.0225	K/W
$R_{th(j-c)}$	rec. 120°	SSC		0.06	K/W
		DSC		0.027	K/W
<b>Module</b>					
$R_{th(c-s)}$	SSC		0.01		K/W
	DSC		0.005		K/W
F		22		25	KN
a					m/s <sup>2</sup>
w			480		g

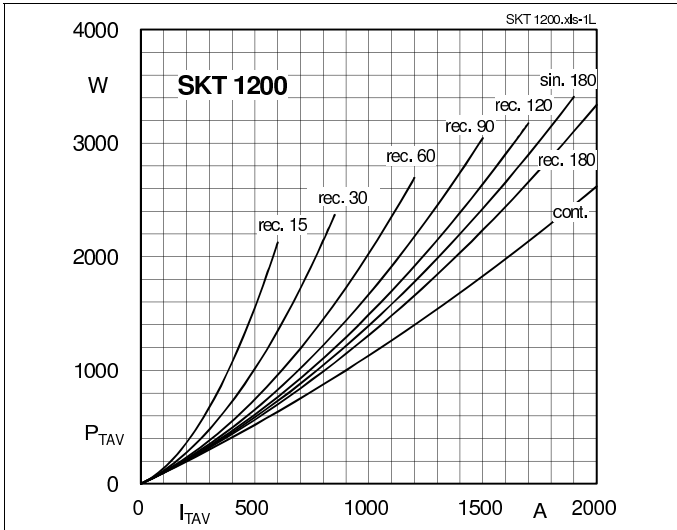

Fig. 1L: Power dissipation vs. on-state current

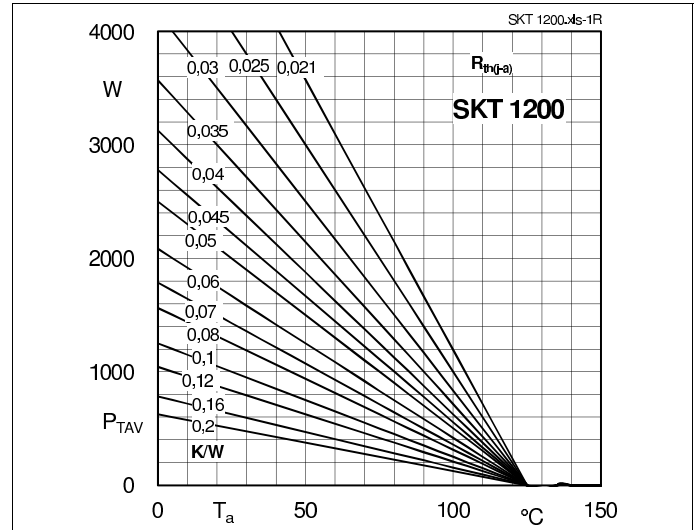

Fig. 1R: Power dissipation vs. ambient temperature

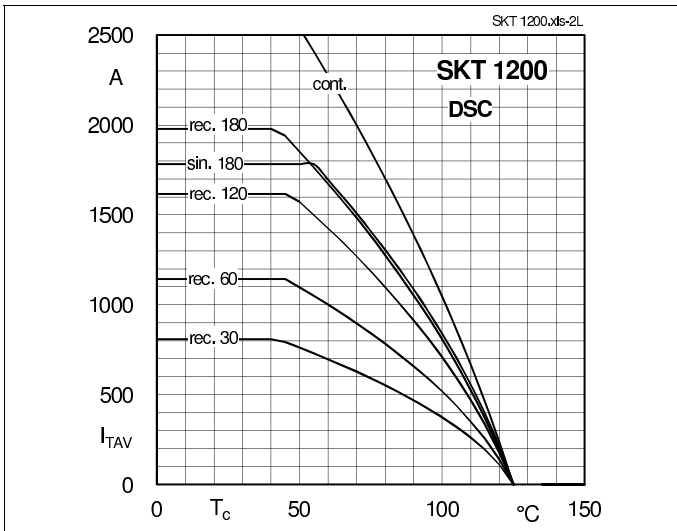

Fig. 2L: Rated on-state current vs. case temperature

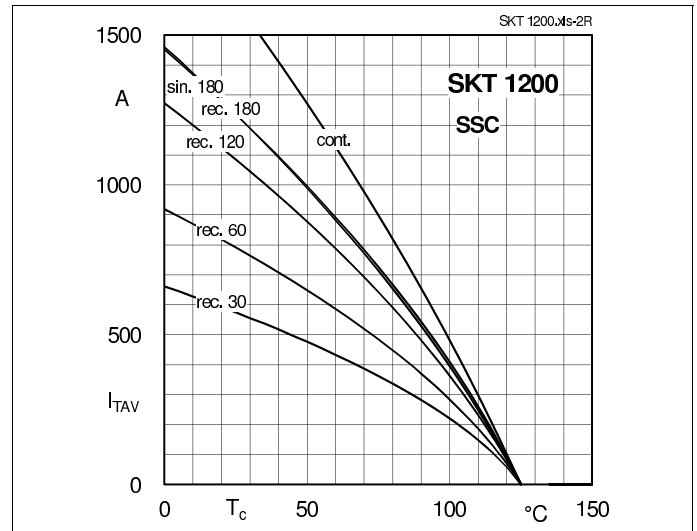

Fig. 2R: Rated on-state current vs. case temperature

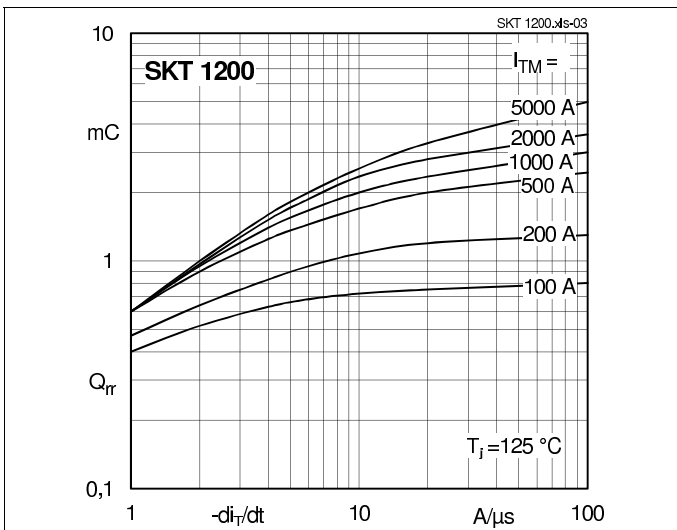

Fig. 3: Recovered charge vs. current decrease

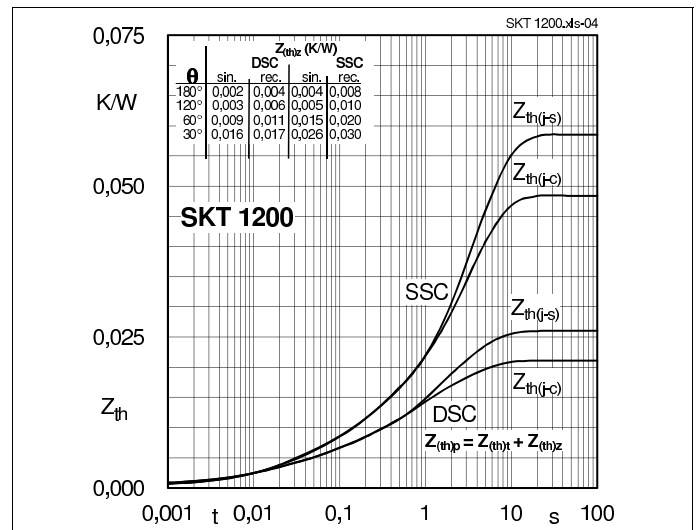

Fig. 4: Transient thermal impedance vs. time

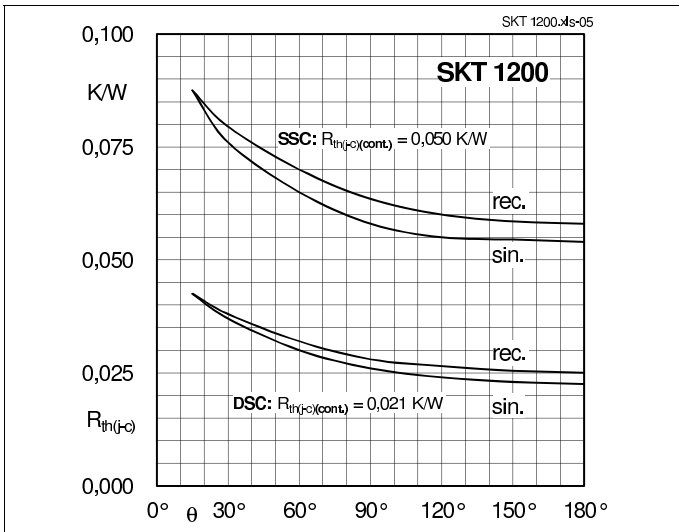

Fig. 5: Thermal resistance vs. conduction angle

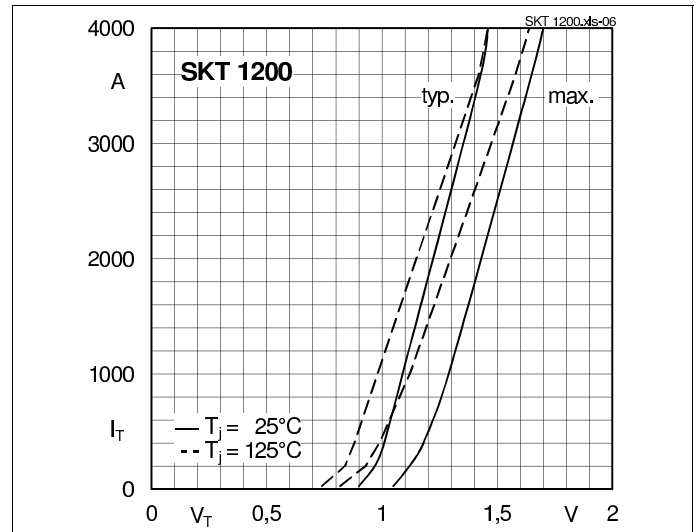

Fig. 6: On-state characteristics

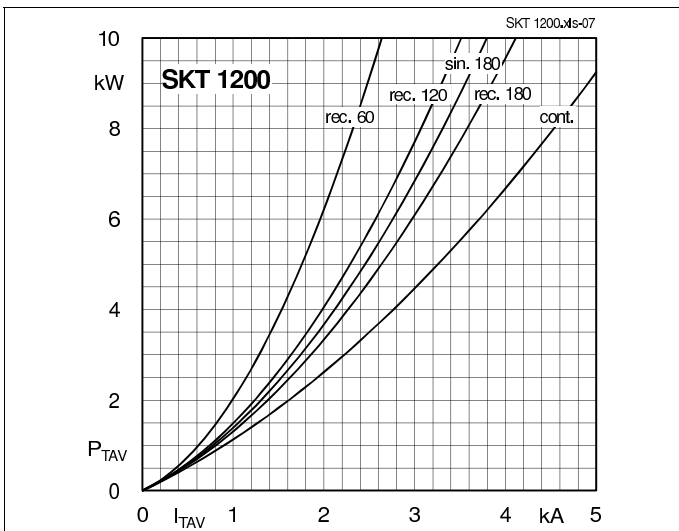

Fig. 7: Power dissipation vs. on-state current

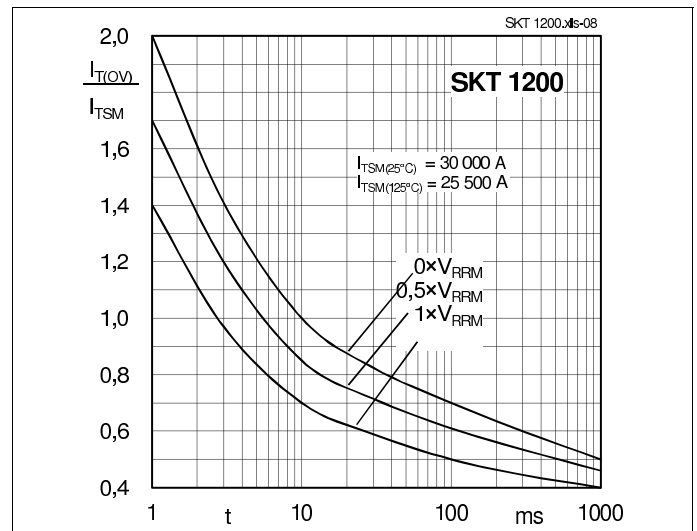

Fig. 8: Surge overload current vs. time

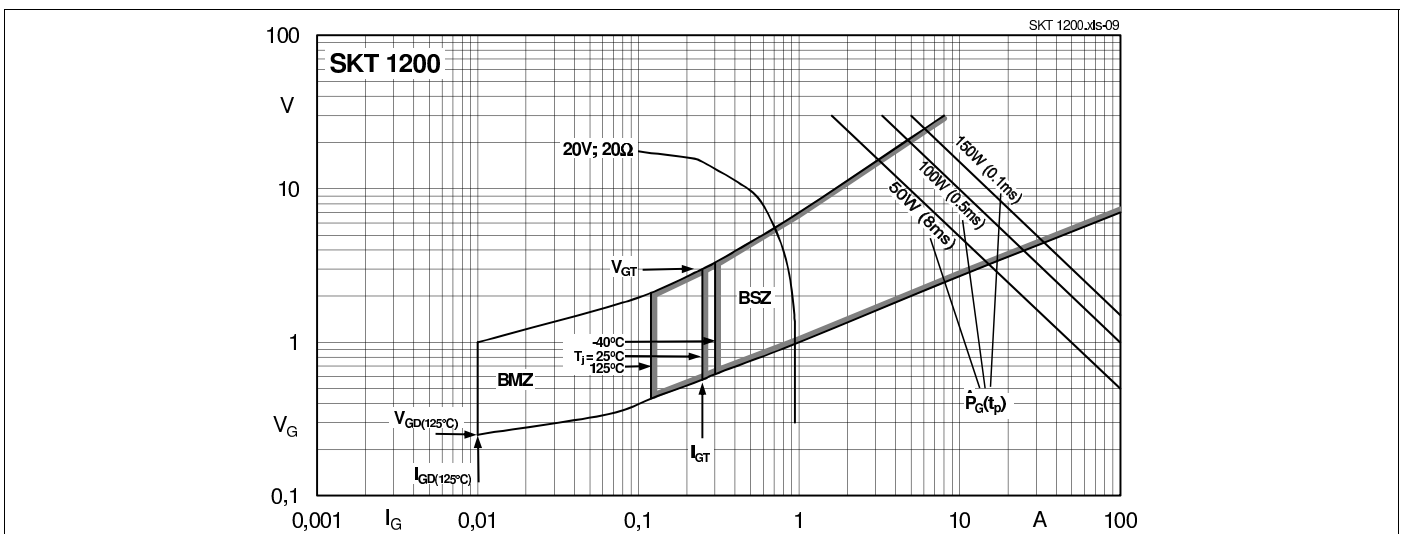
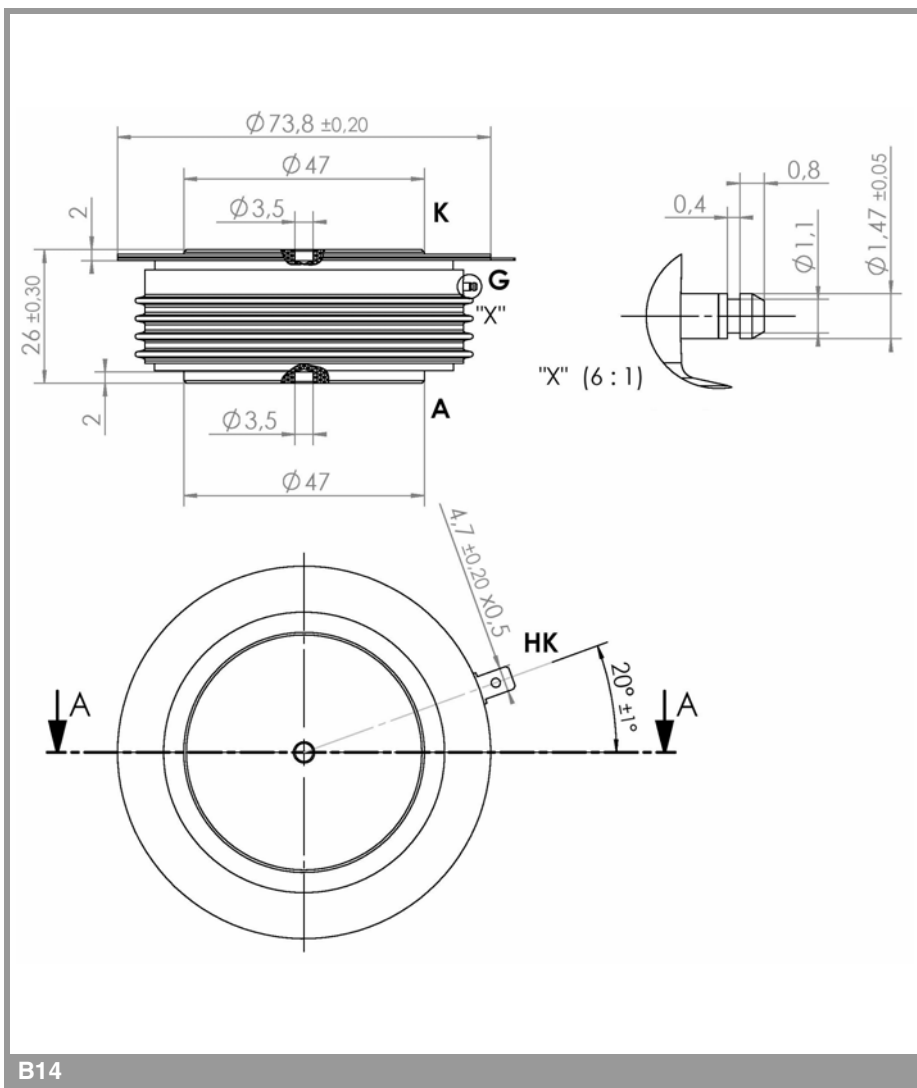
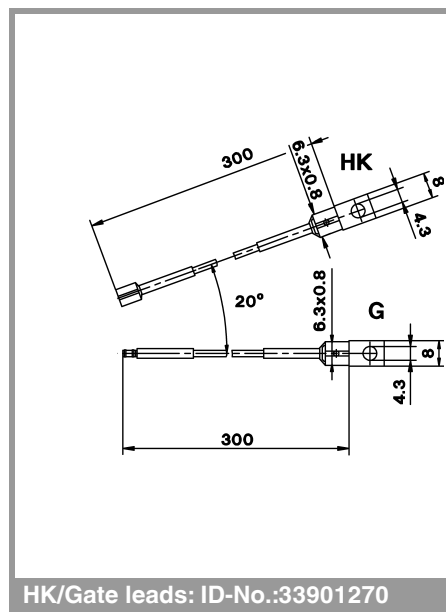

Fig. 9: Gate trigger characteristics

# SKT 1200/18 E



B14



HK/Gate leads: ID-No.:33901270

This is an electrostatic discharge sensitive device (ESDS), international standard IEC 60747-1, Chapter IX

\* The specifications of our components may not be considered as an assurance of component characteristics. Components have to be tested for the respective application. Adjustments may be necessary. The use of SEMIKRON products in life support appliances and systems is subject to prior specification and written approval by SEMIKRON. We therefore strongly recommend prior consultation of our staff.